



E X L 8 9 4 5

# OWNER'S MANUAL

900 MHz Cordless  
Phone

Long Distance  
Manager

Dual Keypad  
Operation

3-Way Conference  
Operation

**Uniden®**

# INTRODUCTION

TO YOUR NEW PHONE

## Introduction

Thank you for choosing the Uniden EXL 8945 cordless telephone. This phone is designed to exacting standards that provide reliability, long life and outstanding performance.

**Note: Some illustrations in this manual may differ from the actual unit for explanation purposes.**

## Features

- 900 MHz Extended range
- Secure Digital Transmission
- Long Distance Manager
- 20 Number Memory (10 on the base and 10 on the handset)
- 32 Digit Redial
- Redial, Flash and Pause
- Pulse / Tone Dialing
- 7 Day Standby Battery Life
- 7 Hour Talk Time
- Handset Earpiece and Ringer Volume Control
- Speakerphone
- 3-Way Conference Operation
- Dual Keypad Operation
- Intercom

# Controls and functions

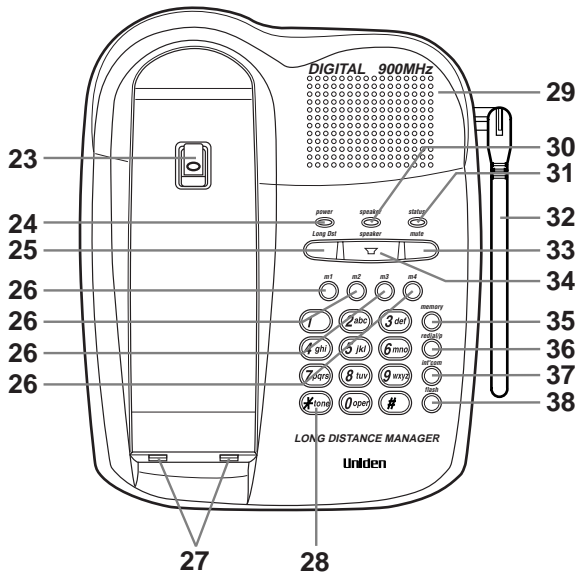
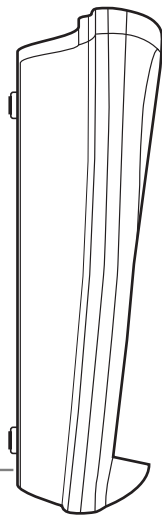
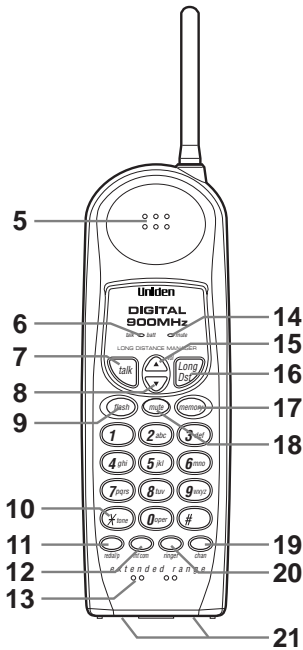
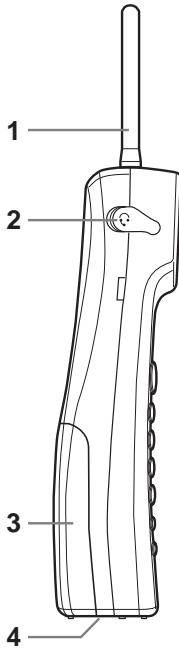

- |                                |                                   |
|--------------------------------|-----------------------------------|
| 1. Handset antenna             | 22. Base microphone               |
| 2. Headset jack cover          | 23. Handset retainer clip storage |
| 3. Handset battery compartment | 24. Power LED                     |
| 4. Handset ring switch         | 25. Long Distance Manager key     |
| 5. Handset earpiece            | 26. One touch dial (m1 - m4) key  |
| 6. Talk/Battery LED            | 27. Base contact                  |
| 7. Talk key                    | 28. Tone key                      |
| 8. Volume down key             | 29. Base speaker                  |
| 9. Flash key                   | 30. Speaker LED                   |
| 10. Tone key                   | 31. Status LED                    |
| 11. Redial/Pause key           | 32. Base antenna                  |
| 12. Intercom key               | 33. Mute key                      |
| 13. Handset microphone         | 34. Speaker key                   |
| 14. Mute LED                   | 35. Memory key                    |
| 15. Volume up key              | 36. Redial/Pause key              |
| 16. Long Distance Manager key  | 37. Intercom key                  |
| 17. Memory key                 | 38. Flash key                     |
| 18. Mute key                   | 39. Base speaker volume adjust    |
| 19. Channel key                | 40. Ring volume switch            |
| 20. Ringer Select key          | 41. Pulse-Tone switch             |
| 21. Handset contact            | 42. DC power input                |
|                                | 43. Phone jack                    |

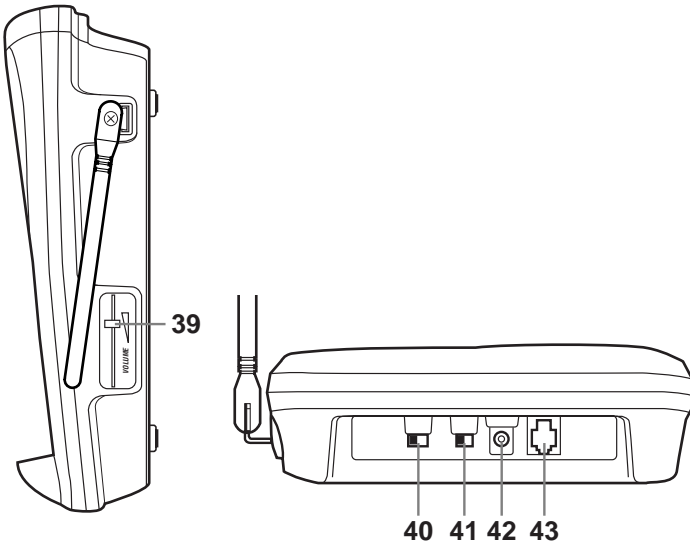

# CONTENTS

OF YOUR OWNER'S MANUAL

## Contents

Introduction / Features.....inside front cover  
Control and Functions.....inside front cover

### Getting Started

Read this first.....3  
Step 1: Checking the package contents .....4  
Step 2: Setting up the base unit .....5  
    Mounting the base unit on a wall .....8  
Step 3: Preparing the battery pack .....10

### Basics

Making a call .....12  
Using the Long Distance Manager (LDM) .....13  
Receiving a call .....15  
Adjusting ringer and earpiece volume .....16  
Redialing a call .....17  
Using the speakerphone .....18  
Mute .....19

### Memory Dialing

Storing phone numbers .....20  
Making calls with memory dialing.....21  
Erasing a stored phone number.....22

### 3-way Conference Features

3-way conferencing.....23  
Using your EXL 8945 intercom.....24  
Transferring a call.....25

### Additional Information

Changing the digital security code.....26  
Installing the beltclip.....27  
Headset installation.....27  
Note on power sources .....28  
Maintenance.....28

**Troubleshooting**.....29

**Specifications**.....30

**Index** .....31

Getting Started

Basics

Memory Dialing

3-way  
Conference  
Features

Additional  
Information

Troubleshooting

Specifications

Index

## Read this first

This cordless telephone must be set up before use. Follow these steps;

### Step 1 (page 4)

Unpack the telephone and accessories.

### Step 2 (page 5 to 9)

Next, choose the best location to set up the base unit.



**Base unit**

### Step 3 (page 10 to 11)

Then, insert the battery pack into the handset. You have to charge the battery pack for more than 12-15 hours before using the phone.



**Handset**

### About the digital security code

This cordless telephone uses a digital security code to prevent unauthorized access to your base unit. This security code prevents other cordless handsets from making calls through your base unit. A random security code will be assigned automatically between your base unit and handset when you charge the battery pack for the first time.

If you want to reset the security code, see page 26.

## Checking the package contents

Make sure you have received the following items in the package. If any of these items are missing or damaged, contact the **Uniden Parts Department** (see below).



• Base unit



• Handset

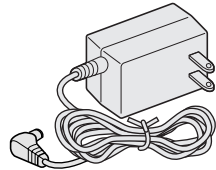

• AC adapter (AD-420)

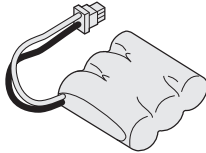

• Rechargeable battery pack (BT-905)

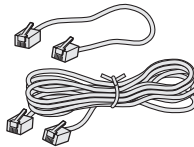

• Telephone line cord (2)

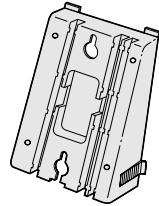

• Wall mount adapter

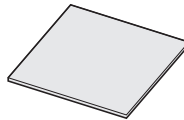

• Memo sticker

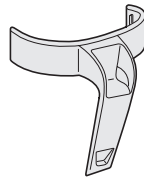

• Beltclip

- This Owner's Manual
- Precautions and Important Safety Instructions
- Registration Card

### Uniden Parts Department

(800) 554-3988

Hours: M-F 8:30 AM to 5:00 PM CST.

We can also be reached on the web at [www.uniden.com](http://www.uniden.com).

## Setting up the base unit

Do the following steps.

- Choose the best location
- Connect the base unit
- Choose the dialing mode

### Choose the best location

Before choosing a location for your new phone, read the INSTALLATION CONSIDERATIONS included in the PRECAUTIONS AND IMPORTANT SAFETY INSTRUCTIONS brochure. Here are some important guidelines you should consider:

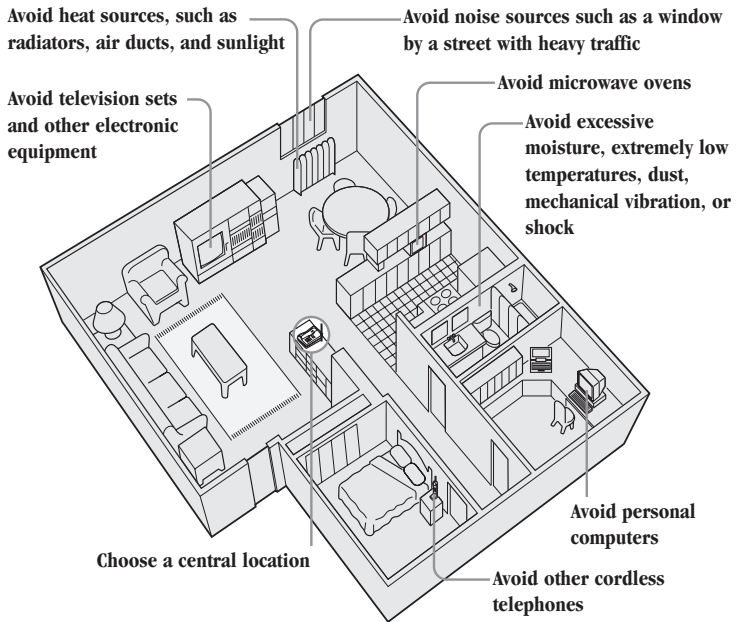

- You should charge your handset for 12-15 hours before using the phone.
- The location should be close to both a phone jack and continuous a power outlet which is not switchable.
- Keep the base and handset away from sources of electrical noise such as motors and fluorescent lighting.
- Be sure there is sufficient space to raise the base antenna fully vertical.
- The base can be placed on a desk, tabletop or mounted on a standard wall plate.



## Connect the base unit

If you want to install the base unit on the wall, see page 8.



Place the power cord so it does not create a trip hazard, or where it could become chafed and create a fire or electrical hazard.

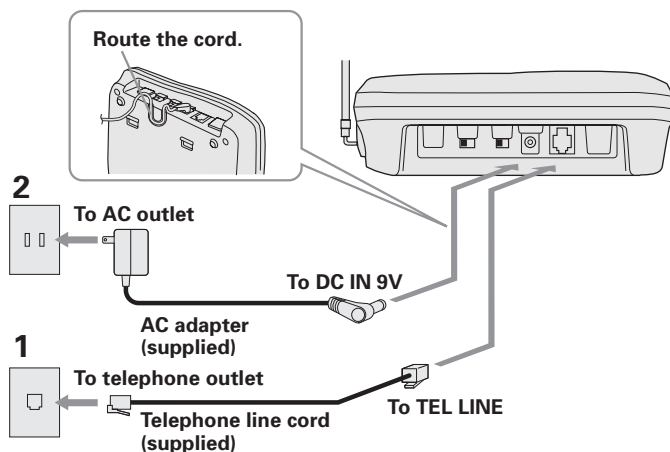

- 1** Connect the telephone line cord to the **TEL LINE** jack and to a telephone outlet.
- 2** Connect the AC adapter to the **DC IN 9V** jack and to a standard 120V AC wall outlet.
- 3** Set the base unit on a desk or tabletop and place the handset on the base unit. Then raise the antenna to a vertical position.

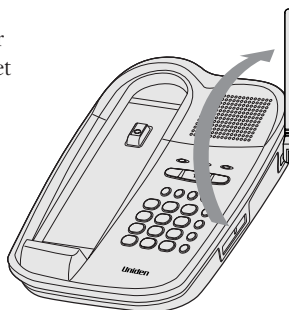



Use only the supplied AD-420 AC adapter. Do not use any other AC adapter.

**Polarity of the plug**

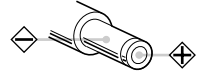

Connect the AC adapter to a continuous power supply.



If your telephone outlet isn't modular, contact your telephone company for assistance.

**Modular**



## Choose the dialing mode

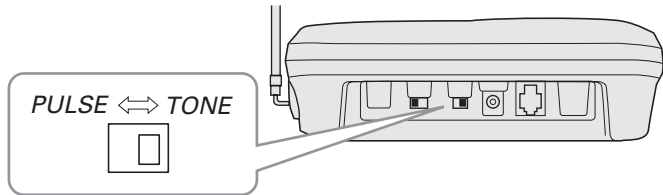

Depending on your dialing system, set the **TONE/PULSE** switch as follows:

If your dialing system is	Set the switch to
Tone	<b><i>TONE</i></b>
Pulse	<b><i>PULSE</i></b>

### If you aren't sure of your dialing system

Make a trial call with the **TONE/PULSE** switch set to ***TONE***. If the call connects, leave the switch as is; otherwise, set to ***PULSE***.

# Mounting the base unit on a wall

## Standard wall plate mounting

This phone can be mounted on any standard telephone wall plate.

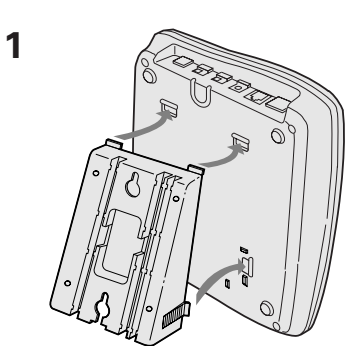

**1** Snap the wall mount adapter into the notches on the base.

**2** Plug the telephone line cord to the **TEL LINE** jack and the AC adapter to the **DC IN 9V** jack.

**3** Plug the telephone line cord into the telephone outlet.

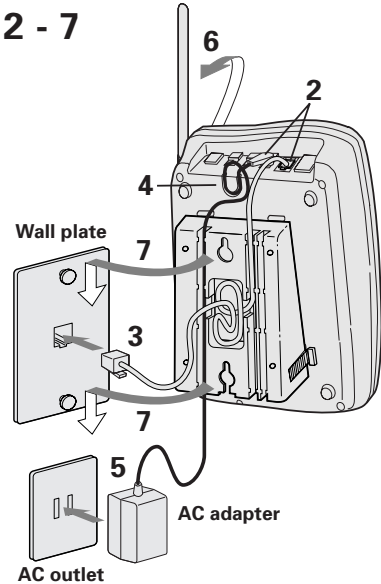

**4** Wrap the AC adapter cord inside the molded wiring channel. Then wrap the cord around the strain relief notch.

**5** Plug the AC adapter into a standard 120V AC wall outlet.

**6** Raise the antenna to a vertical position.

**7** Align the mounting slots on the base with the mounting posts on the wall. Push in and down until the phone is firmly seated.

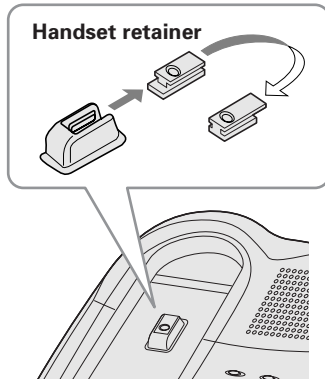

**8** On the base unit, pull the handset retainer out of the slot. Rotate it clockwise 180 degrees.

**9** Flip the retainer from front to back. Slide it back into the slot so that the lip of the retainer is up and the oval is down. The retainer holds the handset in place.

## Direct wall plate mounting

If you don't have a standard wall plate, you can mount your phone directly to the wall. Before doing this, consider the following:

- Avoid electrical cables, pipes, or other items behind the mounting location that could cause a hazard when inserting screws into the wall.
- Try to mount your phone within 10 - 15 feet of a working phone jack to avoid excessive cord lengths.
- Make sure the wall material is capable of supporting the weight of the base and handset.

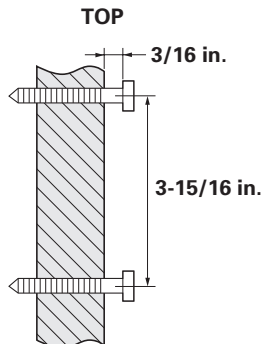

**1** Insert two mounting screws into the wall, (with their appropriate anchoring device), 3-15/16 inches apart. Allow about 3/16 of an inch between the wall and screwheads for mounting the phone.

**2** Refer to steps 1 through 9 on page 8 and 9 to mount the telephone.

## Preparing the battery pack

Charge the battery pack for more than 12-15 hours before you start using your phone.

### NOTE

Use only Uniden Battery BT-905.

**1** Press the battery cover release.

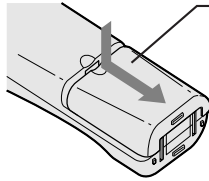

**2** Connect the battery pack connector with the correct polarity (black and red wires), then insert the battery pack into the battery compartment.

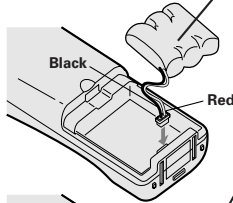

**3** Slide the battery cover forward until it snaps into place.

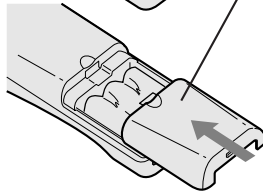

**4** Place the handset on the base. Make sure that the "**status**" LED of the base unit lights, and charging begins. Charge the battery for at 12-15 hours. You can place either side up for charging the battery.

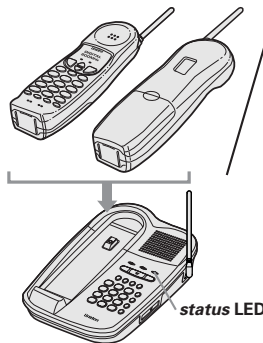



### NOTE

Even when the battery pack is not being used, it will gradually discharge over a long period. For optimum performance, be sure to return the handset to the base unit after a telephone call for charging the battery.



### NOTE

The built-in memory backup can hold numbers and names stored in the memory for up to 2 minutes, while you replace the battery pack.



### NOTE

If you must replace the battery pack during a telephone call, complete the replacement of the battery pack within 30 seconds, and you can return to the original call.



### NOTE

Rechargeable batteries have a memory effect that reduces standby and talk time. To avoid this memory effect, on a monthly basis, use the phone until the **batt** LED blinks. Then charge the battery for 15 hours.

## Battery use time (per charge)

From fully charged

- Seven hours continuous use.
- Seven days when the handset is in the standby mode.

## When the battery charge becomes low

When the voltage of battery pack in the handset is very low and needs to be charged, the phone is programmed to eliminate functions in order to save power. If the battery charge becomes low Battery lamp blinks. If the phone is in use, the handset beeps. Complete your conversation as quickly as possible and return the handset to the base unit for charging.

## Cleaning the battery contacts

To maintain a good charge, it is important to clean all battery contacts on the handset and base unit about once a month. Use a pencil eraser or other contact cleaner.

**Do not use any liquids or solvents.**

## Making a call

### From the handset

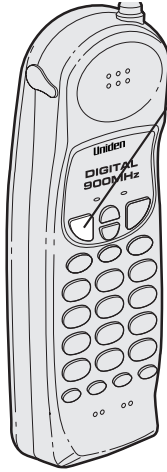

- 1 Pick up handset.
- 2 Press **(talk)**.
- 3 Dial the phone number.
- 4 To hang up, press **(talk)** or return the handset to the base.

### NOTE

The phone number can be up to 32 digits.

### From the base

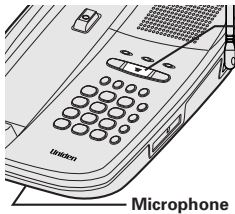

- 1 Press **(speaker)**.
- 2 Dial the number on the keypad.
- 3 When you finish the call, press **(speaker)** to hang up.

### Other Operations

To	Do this
To improve reception	Press <b>(chan)</b> .
To adjust the earpiece volume	Press <b>(▲)</b> or <b>(▼)</b> during the call.
To temporarily switch to tone dial (When base is set to pulse mode)	Press <b>(* tone)</b> . The following numbers dialed will be sent as tone dialing.
To enter a pause within the numbers dialed	Press <b>(redial/p)</b> .
To receive a new call during the conversation	Press <b>(flash)</b> .

## Using the Long Distance Manager (LDM)

### Sign up and Registration

1. Before using the LDM feature, you must register your phone by calling 1-800-458-2682.
2. You will be asked a few simple questions, such as name, address, and phone number.
3. Each month you will receive an itemized bill for calls placed through the LDM service.

### Placing a call using LDM

Press **(LongDst)** key before dialing a long distance (1+) or international (011+) number.

### LDM call from the handset

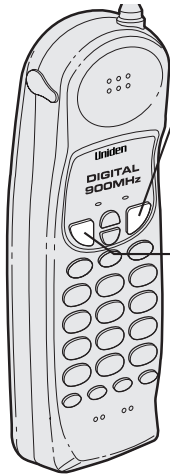

- 1 Pick up your phone.
- 2 Press **(LongDst)**.
- 3 Dial the phone number.  
You must dial a "1" or "011" when using the LDM feature.
- 4 Press **(talk)** or return the handset on the base to finish the call.

### LDM call from the base

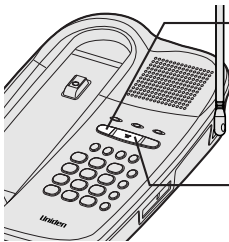

- 1 Press **(LongDst)**.
- 2 Dial the phone number.  
You must dial a "1" or "011" when using the LDM feature.
- 3 Press **(speaker)** to finish the call.



## Private Branch Exchange (PBX) dialing

### NOTE

Redial will not function when using LDM through PBX.



### From the handset

- 1 Press **(talk)** .
- 2 Dial out by entering 9 on the keypad, or any sequence of numbers required to access an outside line.
- 3 Press **(LongDst)** and you can make a LDM call.
- 4 Dial a long distance or international number.
- 5 Press **(talk)** to finish the call.

### LDM call from the base

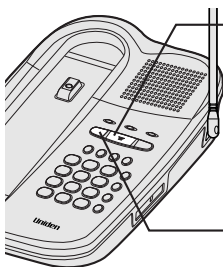

- 1 Press **(speaker)** .
- 2 Dial out by entering 9 on the keypad, or any sequence of numbers required to access an outside line.
- 3 Press **(LongDst)** and you can make a LDM call.
- 4 Dial a long distance or international number.
- 5 Press **(speaker)** to finish the call.

### NOTES

- You must dial a "1" or "011" when using the LDM feature.
- **Do NOT USE (LongDst) BUTTON TO DIAL 911 BECAUSE IT WILL NOT ACCESS EMERGENCY SERVICE.**
- Do not use the **(LongDst)** for placing local calls, contacting your local phone company for repair or customer service, accessing emergency service or for toll free numbers.
- All calls placed through the LDM feature will be charged at the applicable toll rate for the specific call.
- Failure to register will result in lost savings.

## Receiving a call

### From the handset

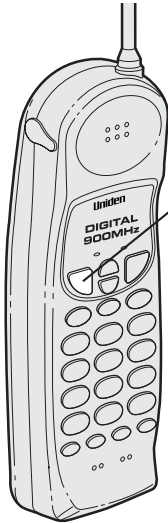

#### Handset on the base

- 1 Phone rings.
- 2 Pick up the handset and speak.
- 3 Press **talk** or return the handset to the base to finish the call.

#### Handset off the base

- 1 Phone rings.
- 2 Press **talk** or any key, and speak.
- 3 Press **talk** or return the handset to the base to finish the call.

### From the base

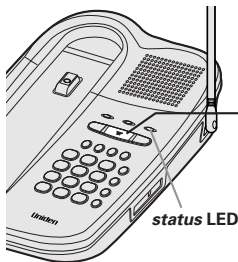

- 1 The phone rings. The **status** LED on the base flashes.
- 2 Press **speaker**.
- 3 Press **speaker** to finish the call.

## Adjusting the ringer and earpiece volume

### Handset ringer tone

In the standby mode, press **ringer**.

Each time **ringer** is pressed, the ringer tone setting changes and the selected ringer tone sounds for 2 seconds.

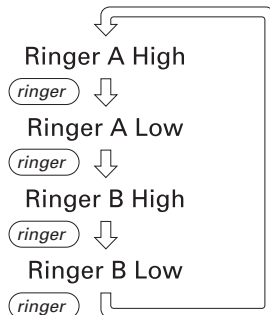

### Handset ringer switch

This switch turns the handset ringer on or off.

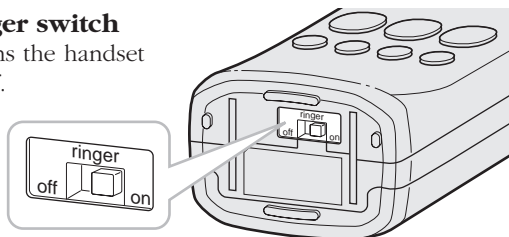

### Handset earpiece volume

Pressing **▲** or **▼** during a telephone call will change the earpiece volume of the handset. This setting will remain in effect after the telephone call has ended.

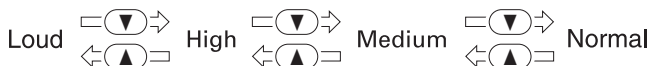

When you press **▲** in Maximum mode or press **▼** in Low mode, error sound beeps.

### Base ringer switch

This switch turns the base unit ringer on or off.

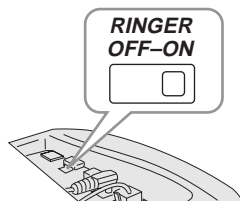

### Base speaker volume

To control the speaker volume of the base, adjust the **VOLUME** slide switch as desired.

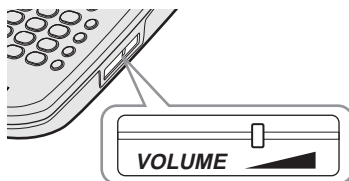

## Redialing a call

### From the handset

The last phone numbers entered can be quickly redialed.

#### NOTE

If the recently dialed number exceeds 32 digits, only the first 32 digits are retained for redialing.

#### NOTE

If you use Long Distance Manager press **(LongDst)** instead of **(talk)** or **(speaker)**.



### Handset on the base

- 1 Pick up handset.
- 2 Press **(talk)**.
- 3 Press **(redial/p)**.
- 4 Press **(talk)** or place the handset on the base to hang up.

### Handset off the base

- 1 Press **(talk)**.
- 2 Press **(redial/p)**.
- 3 Press **(talk)** or place the handset on the base to hang up.

### From the base

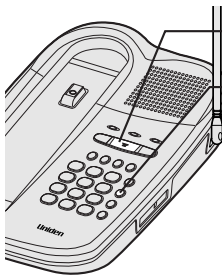

- 1 Press **(speaker)**.
- 2 To call the last number dialed from the base, press **(redial/p)**.
- 3 Press **(speaker)** to finish the call.

## Using the speaker phone

You may use the base as speakerphone. To answer calls, press the **(speaker)** on the base. To hang up, press **(speaker)** again.

The base microphone is located under the base. Position yourself approximately 12 inches away from the base and speak clearly.

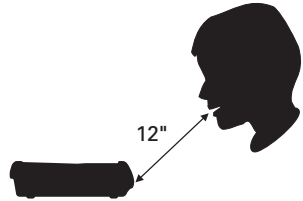

## Mute

You can turn off the base or handset microphone.

### When speaking on the base



- 1 Press **mute** during a telephone call to turn off the microphone.
- 2 To cancel mute, press **mute** , or **speaker** .

### When speaking on the handset

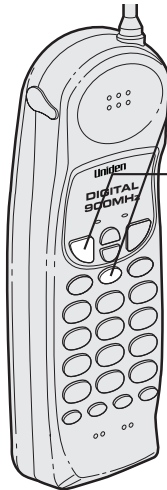

- 1 Press **mute** during a telephone call to turn off the handset microphone. The sound from the microphone is cut off.
- 2 To cancel mute, press **mute** or **talk** .

### When phone is ringing

#### Ringer mute

Press **mute** when the phone rings to immediately mute the ring.



You must press a key within 20 seconds or the phone will return to standby. If you return the handset to the cradle, the phone will return to standby too. Press **(memory)** and you can go to memory menu at any time.

## Storing phone numbers

Your EXL 8945 stores up to 10 numbers in handset plus 10 numbers in the base.

### On the handset



- 1 Press and hold **(memory)** in the standby mode.
- 2 Enter the number you wish to store (up to 20 digits)
- 3 Press **(memory)** again.
- 4 Press the **(0)** to **(9)** on the keypad to select the memory location you wish to store the number.
- 5 The confirmation beep indicates the number has been stored.

### On the base

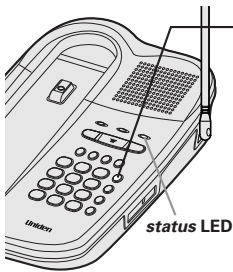

- 1 Press **(memory)**.  
The **status** LED blinks.
- 2 Dial the number you wish to store.
- 3 Press **(memory)**.  
Press **(0)** to **(9)** on the keypad to select the memory location you wish to store the number.  
The **status** LED goes out.  
A confirmation beep indicates the number is stored.



When entering numbers, you may press **(redial/p)** to enter a pause in the dialing sequence.



You cannot store phone numbers directly into the one-touch dial keys. See page 21 for one touch dialing.

## Making calls with memory dialing

### From the handset

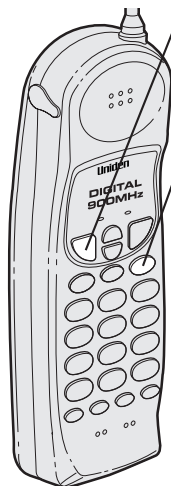

- 1 Press **(talk)** .
- 2 Press **(memory)** .
- 3 Press **(0)** to **(9)** on the keypad to select the memory location you wish to dial.
- 4 Press **(talk)** or return the handset to the base to finish the call.

### NOTE

You must press key within 20 seconds or the phone will return to standby, you may also press memory to access a memory menu at any time.

### NOTE

If you use Long Distant Manager, press **(LongDst)** , instead of **(talk)** or **(speaker)** .

### From the base

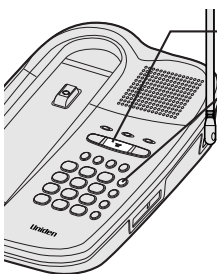

- 1 Press **(speaker)** .
- 2 Press **(memory)** .
- 3 Press **(0)** to **(9)** on the keypad to select the memory location you wish to dial.
- 4 Press **(speaker)** to finish the call.

### One touch memory dialing

Your phone is reequipped with four instant dialing **(m1)**-**(m4)** on the base. YOU CANNOT STORE PHONE NUMBERS DIRECTLY INTO **(m1)** TO **(m4)** .

There are only used to dial phone numbers stored memory location **(1)** - **(4)** on the keypad to instantly dial phone numbers **(m1)** , **(m2)** , **(m3)** or **(m4)** . There is no need to press **(speaker)** , the phone will automatically call.



## Erasing a stored phone number

### From the handset



- 1 Press **memory**.
- 2 Press **memory** again.
- 3 Enter the memory location number (0 - 9) of the number you wish to delete.  
A confirmation tone indicates the memory has erased.

### From the base

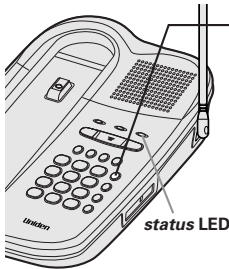

- 1 Press **memory**.  
The **status** LED blinks.
- 2 Press **memory** again.
- 3 Enter the memory location number (0-9) of the number you wish to delete. The **status** LED goes out.  
A confirmation beep indicates the number has been erased.

## NOTE

Pressing the **speaker** key on the base while dialing with the handset will set the 3-way conversation mode and dialing continues.

## NOTE

Pressing the **talk** key on the handset will not set the 3-way conversation mode while in the process of dialing with the base.

## NOTE

Dialing from the 3-way conversation mode is possible only from the handset.

## 3-way conferencing

The Uniden EXL 8945 permits 3-way conversations between the handset, base, and an outside line.



## When speaking on the handset

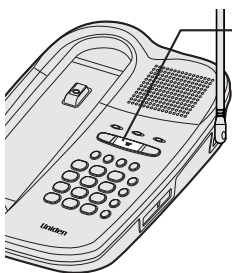

- 1 Press **speaker** on the base. This will set the 3-way conversation mode.
- 2 Press **speaker** on the base to return to the conversation between the handset and outside line.

## When speaking on the base

### When the handset is off the base



- 1 Press **talk** on the handset. This will set the 3-way conversation mode.
- 2 Press **talk** on the handset, to return to conversing between the base and the outside line.

## Using your EXL 8945 intercom

### Intercom from the base to handset



Press mute when paging,  
stops the paging.

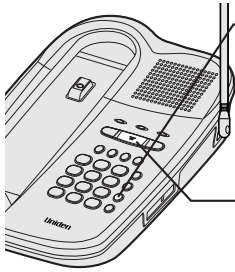

- 1** Press **int'com** on the base.  
The handset beep.
- 2** Press **int'com** or **talk** on the handset.
- 3** To turn off the intercom, press **talk** on the handset or **speaker** on the base.

### Intercom from the handset to base

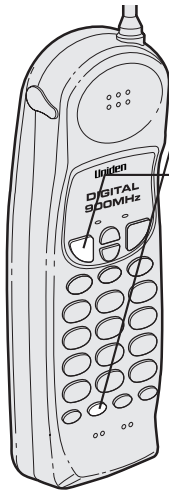

- 1** Press **int'com** on the handset.
- 2** At the base, press **int'com** or **speaker** to answer the page.
- 3** To turn off the intercom, press **talk** on the handset or **speaker** on the base.

## Transferring a call

### To transfer from the handset to the base



- 1** Press **int'com** on the handset while speaking on the handset. The caller is put on hold. The handset and base will enter the intercom mode. The inter'com tone sounds on the base.
- 2** Press **int'com** or **speaker** on the base. The intercom mode is activated, but the caller is still on hold.
- 3** To transfer to the base, press **talk** on the handset.  
To cancel the transfer, press **speaker** on the base.

### To transfer from the base to the handset

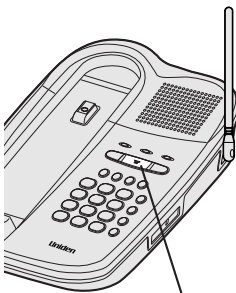

- 1** Press **int'com** on the base while speaking on the speakerphone. The caller is put on hold. The handset and base will enter the intercom mode. The intercom tone sounds on the handset.
- 2** Press **int'com** or **talk** on the handset. The intercom mode is activated, but the caller is still on hold.
- 3** To transfer the handset, press **speaker** on the base.  
To cancel the transfer, press **talk** on the handset.

## Changing the digital security code

### NOTE

If the handset battery pack is completely discharged or the battery pack removed, the digital security code is erased. If this happens, a new security code is set automatically the next time the battery pack is charged.

The digital security code is an identification code used to connect the handset and the base unit. Normally, setting the code is not necessary.

The first time you charge your handset, the security code is automatically set. (See page 3.)

In the rare situation that you suspect another cordless telephone is using the same security code, you can change the code.

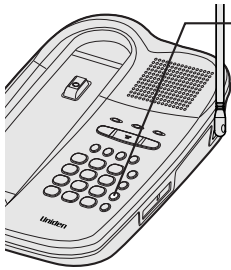

- 1** Remove the handset from the base unit. Press **int'com**.
- 2** While the handset is producing the paging sound, hold **int'com** while placing the handset in the base unit. The paging tone stops. Leave the handset on the base for at least 3 seconds. A new, random security code is set.

## Installing the beltclip

### To attach the beltclip

Insert the beltclip into the holes on each side of the handset. Press down until it clicks.

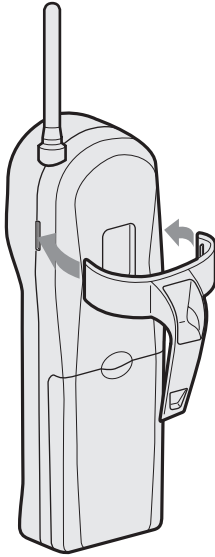

### To remove the beltclip

Pull both sides of the beltclip to release the tabs from the holes.

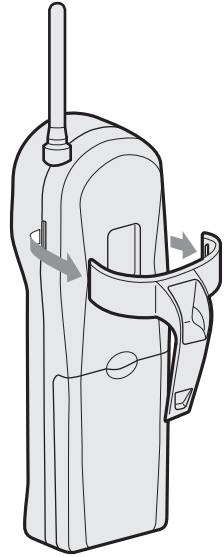

## Headset installation

Your phone may be used with an optional headset. To use this feature, simply plug any standard 2.5mm headset plug into the headset jack. Your phone is ready for hands-free conversation.

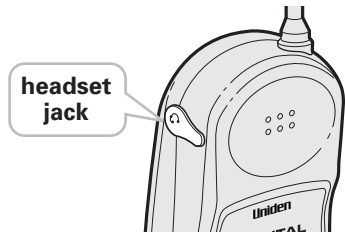

## Note on power sources

### Battery replacement and handling

When the operating time becomes short, even after a battery is recharged, please replace the battery.

With normal usage, your battery should last about one year. Please contact your place of purchase for a replacement battery.

#### Power Failure

During the period that the power is off, you will not be able to make or receive calls with the telephone.

### RECYCLING NICKEL-CADMIUM BATTERIES

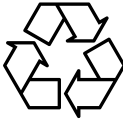

Ni-Cd

**NICKEL-CADMIUM BATTERIES MUST BE DISPOSED OF PROPERLY.**

Nickel-cadmium cells are used in the battery pack. Please take your used nickel-cadmium battery packs to a store that recycles nickel-cadmium batteries.

#### Caution

- Use the specified battery pack.
- Do not remove the battery from the handset to charge it.
- Never throw the battery into a fire, disassemble it, or heat it.
- Do not remove or damage the battery casing.

## Maintenance

#### When slightly dirty

Wipe with a soft, dry cloth.

#### When very dirty

Wipe with a soft cloth that has been dampened with diluted, neutral detergent. Dry with a dry cloth.

#### When the charging terminals become dirty

Wipe with a pencil eraser or other contact cleaner.

#### Caution

Do not use paint thinner, benzene, alcohol, or other chemical products. Doing so may discolor the surface of the telephone and damage the finish.

## Troubleshooting

If your phone is not performing to your expectations, please try these simple steps first.

Symptom	Suggestion
The <b>status</b> LED won't come on when the handset is placed in the base unit.	<ul style="list-style-type: none"> <li>• Make sure the AC adapter is plugged into the base unit and wall outlet.</li> <li>• Make sure the handset is properly seated in the base unit.</li> <li>• Make sure the charging contacts on the handset and base unit are clean.</li> </ul>
The audio sounds weak and/or scratchy.	<ul style="list-style-type: none"> <li>• Make sure that the base unit antenna is in a vertical position.</li> <li>• Move the handset and or base unit to a different location away from metal objects or appliances and try again.</li> <li>• Press (<b>chan</b>) to help eliminate background noise.</li> <li>• Make sure that you are not too far from the base.</li> </ul>
Can't make or receive calls.	<ul style="list-style-type: none"> <li>• Check both ends of the base unit telephone line cord.</li> <li>• Make sure the AC adapter is plugged into the base unit and wall outlet.</li> <li>• Disconnect the AC adapter for a few minutes, then reconnect it.</li> <li>• Reset the digital security code (See page 26).</li> <li>• Make sure (<b>talk</b>) is pressed.</li> </ul>
The handset doesn't ring or receive a page.	<ul style="list-style-type: none"> <li>• The battery pack may be weak. Charge the battery on the base unit for 12-15 hours.</li> <li>• The handset may be too far away from the base unit.</li> <li>• Move the base unit away from appliances or metal objects.</li> <li>• Reset the digital security code (See page 26).</li> </ul>



## Specifications

### General

The EXL 8945 complies with FCC Parts 15 and 68.

Frequency control:	PLL
Modulation:	Frequency shift keying
Operating temperature:	0°C to +50°C (+32°F to +122°F)

### Base unit

RX frequency:	902.119 MHz to 905.016 MHz (30 channel)
TX frequency:	924.997 MHz to 927.894 MHz (30 channel)
Power requirements:	9V 350mA (from AC adapter)
Size:	8-49/64 in. (W) x 6-59/64 in. (D) x 2-37/64 in. (H) (222.5 mm (W) x 175 mm (D) x 65.3 mm (H))
Weight:	Approx. 20.2 oz. (Approx. 572 g)

### Handset

RX frequency:	924.997 MHz to 927.894 MHz (30 channel)
TX frequency:	902.119 MHz to 905.016 MHz (30 channel)
Power requirements:	Rechargeable Nickel-Cadmium battery pack
Size (without antenna):	7-1/64 in. (W) x 2-17/64 in. (D) x 2 in. (H) (178 mm (W) x 57.6 mm (D) x 51 mm (H))
Weight:	Approx. 8.6 oz. (244 g) (including battery)
Battery:	BT-905
	Capacity                      600 mAh, 3.6V
	Talk mode                    7 hours TYP
	Standby mode                7 days TYP

Specifications, features, and availability of optional accessories are all subject to change without prior notice.

## At Uniden, we'll take care of you!

If you need any assistance with this product, please call our Customer Hotline at

**1-800-297-1023**

**PLEASE DO NOT RETURN THIS PRODUCT TO THE PLACE OF PURCHASE.**

Our Uniden representatives will be happy to help you with any matters regarding the operation of this unit, available accessories, or any other related matters.

Thank you for purchasing a Uniden product.

Hours: M-F 7:00 AM to 7:00 PM CST.

## Index

### 0 - 9

3-way conferencing.....23

### A, B

Base ringer switch.....16

Battery pack

    Preparing and charging ....10

    Replacement and  
    handling .....28

### C

Channel.....12

Connection .....6

### D

Dialing mode.....7

Digital security code .....3,26

### E, F, G

Earpiece volume.....16

### H

Headset installation.....27

### I, J, K, L

Intercom.....24

Installing the beltclip .....27

LDM

(Long Distance Manager).....13

### M, N, O

Maintenance.....28

Making a call .....12

Memory dialing

    Making a call

    with memory dialing.....21

    Erasing a stored phone

    number.....22

    Storing phone numbers

    and names .....20

Mounting the base unit

to a wall.....8

Mute .....19

### P, Q

Package contents.....4

### R

Receiving a call .....15

Redialing a call .....17

Handset ringer tone .....16

Handset ringer switch.....16

### S

Setup

    Base unit.....5

    Handset.....10

Speaker phone .....18

Specifications .....30

### T, U, V, W, X, Y, Z

Transferring a call.....25

Troubleshooting .....29







# THANK YOU

FOR PURCHASING A UNIDEN PHONE!

## Uniden®

Covered under one or more of the following U.S. patents:

4,511,761 4,523,058 4,595,795 4,797,916 5,381,460  
5,426,690 5,434,905 5,491,745 5,533,010 5,574,727  
5,650,790 5,660,269 5,661,780 5,663,981 5,671,248  
5,717,312 5,754,407 5,768,345 5,787,355 5,838,721

© June 1999 Uniden America Corporation

All rights reserved • Printed in China UCZZ01622ZZ